

DIN导轨  
安装位

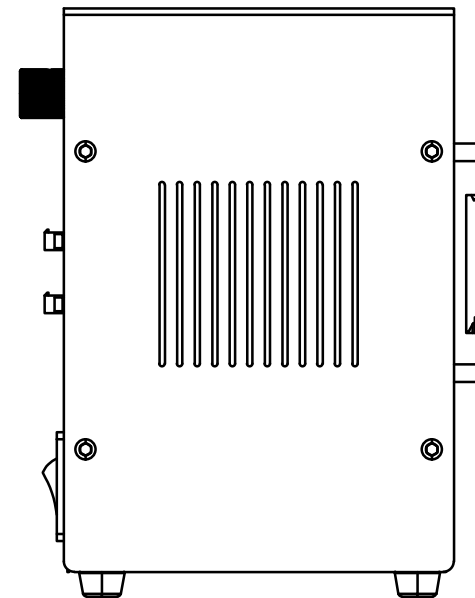
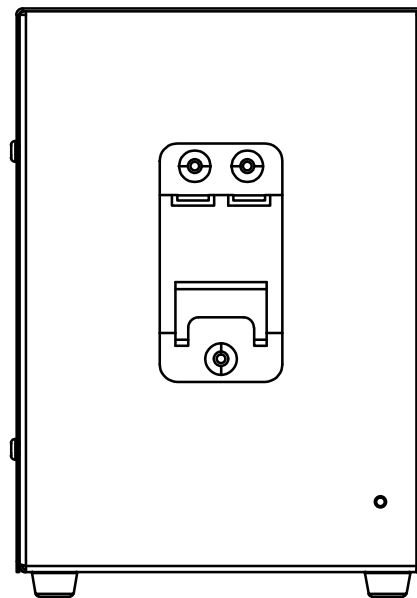
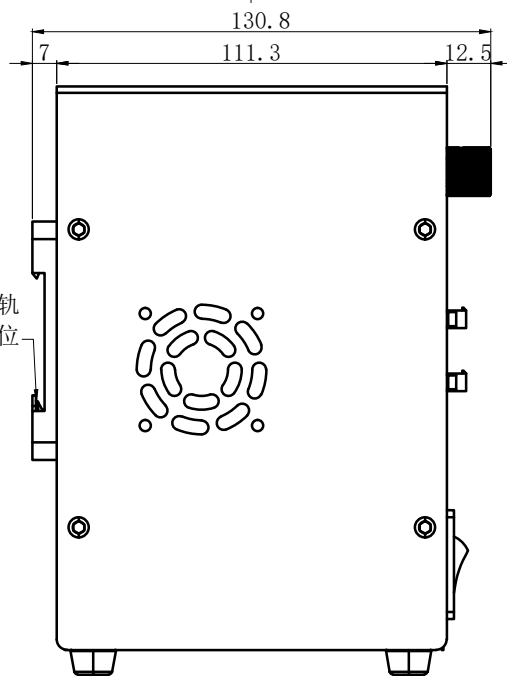

产品安装尺寸图		设计	王素梅	2022.03.10		wordop 沃德普	
输入电压: AC110/220V	输出电压: DC24V/DC48V	审核					
调光方式: 256级PWM调节	触发输入电压: DC5-24V	估重	视角方向	比例	单位	名称	数字控制器
				1:1	mm	型号	PBD-12048-4-LSE