

JST-SMR-03V-B

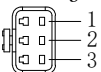

Pin1 -- 棕色/+
Pin2 -- 空 /NC
Pin3 -- 蓝色/-

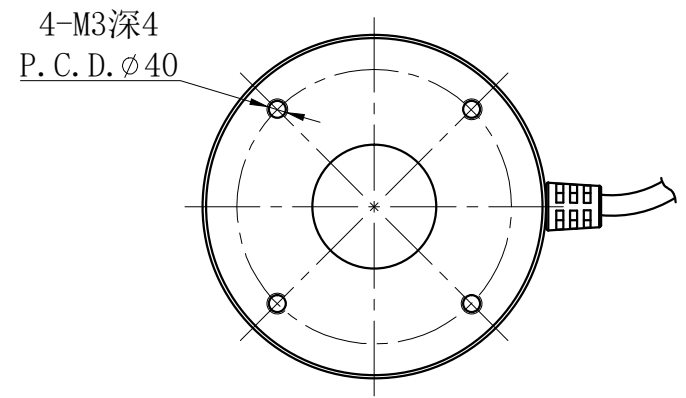
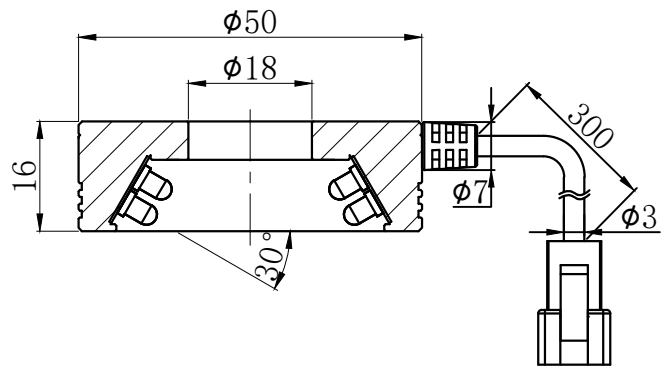
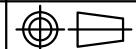

产品安装尺寸图					设计	陈博君	2021.08.26		wordop®沃德普	
输入电压	理论电耗功率				审核					
	红色 (R)	白/蓝/绿色 (WGB)	红外 (IR)	紫外 (UV)	估重	视角方向	比例	单位	型号	LAR3-50-30
24V	2.0W	2.6W			50g		1:1	mm		